



REPLACEMENT PARTS GUIDE

Z970R ZTrak R Series Mower

ENGINE



SPARK PLUG
[M802138](#)
Change Every 1000 Hrs.



FUEL FILTER-IN-LINE
[AM116304](#) (USE WITH MIA12352)
[UC21217](#) (USE WITH AUC13997)
Change Every 300/600 Hrs.



ENGINE OIL FILTER
[AM107423](#)
Change Every 100/200/300 Hrs.



ENGINE OIL
[TY22029](#) (TURF GARD™ 10W30)
1.9L (2.0 qt)
Change Every 100/200 Hrs.



AIR FILTER
[M131802](#) (PRIMARY)
Change every 300 Hrs.
[M131803](#) (SECONDARY)
Change every 500 Hrs.



HEADLIGHT
[TCB11281](#) (27W)



CASTER WHEEL
[TCA19309](#)



KEY
[AUC12681](#) (S/N - 030000)
[TCA24616](#) (S/N 030001 - 060000)
[AUC12681](#) (S/N 060001 -)



BATTERY
[TY25878B](#) (12V) (FOR USA AND CANADA)
[MCYP340PF](#) (12V) (NOT FOR USA AND CANADA)



ELECTRICAL



STARTER MOTOR
[AUC12593](#)



IGNITION SWITCH
[TCA22740A](#) (S/N - 030000)
[UC18708](#) (S/N 030001 -)

FUEL AND AIR



FUEL TANK FILLER CAP
[TCA23672](#) (S/N - 060000)
[AUC11638](#) (S/N 060001-)



MUFFLER
[TCA26233](#)



PTO CLUTCH
[AUC18216](#)



TRACTION DRIVE BELT
[TCU34299](#) (LGTH = 1803.9 mm,
WIDTH= 16 mm)



JD MULTI PURPOSE HD LITHIUM COMPLEX GREASE
[TY24416](#)
Change Interval:As needed.



GREASE GUN
[TY26518](#)

REPLACEMENT PARTS GUIDE

Z970R With 60 inch Deck

MOWER DECK

MOWER BLADE
[TCU15881](#) (HIGH LIFT)
[UC15158](#) (HIGH LIFT SELF SHARPENING)
[M128485](#) (STANDARD LIFT)
[M133381](#) (LOW LIFT)
[M168223](#) (MULCH)

SPINDLE KIT
[AUC12478](#)

IDLER
[AUC11584](#) (OD = 201 mm)
[TCA20602](#) (OD = 148 mm)
[TCA22651](#) (196.85 mm)

SHEAVE
[TCU26967](#) (OD = 187.10 mm)

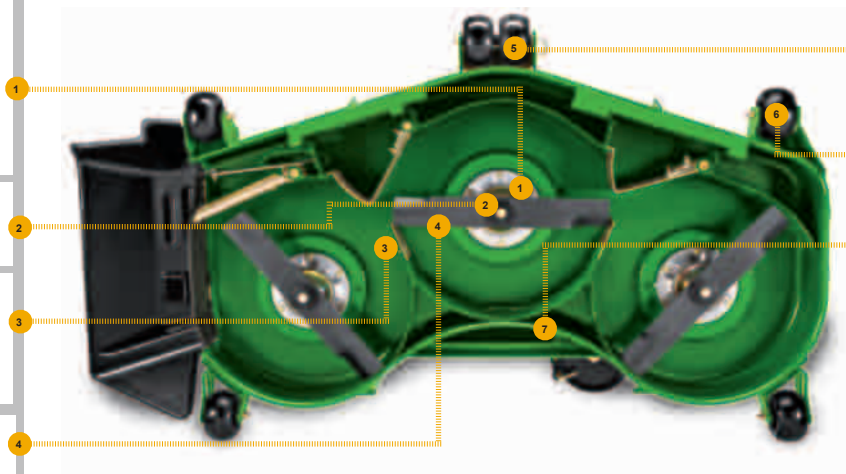

MOWER DECK

ROLLER
[TCU34060](#)

GAGE WHEEL
[UC28193](#)

V - BELT
[TCU35604](#) (LGTH = 4635 mm,
 WIDTH = 14 mm, TK = 18 mm)

REPLACEMENT PARTS GUIDE

Z970R With 60 inch Mulch On demand Deck

MOWER DECK

MOWER BLADE

- [TCU15881](#) (HIGH LIFT)
- [UC15158](#) (HIGH LIFT SELF SHARPENING)
- [M128485](#) (STANDARD LIFT)
- [M133381](#) (LOW LIFT)
- [M168223](#) (MULCH)
- [TCU18990](#) (MULCH ON DEMAND™)

SPINDLE KIT

- [AUC12478](#)

IDLER

- [AUC11584](#) (OD = 201 mm)
- [TCA20602](#) (OD = 148 mm)
- [TCA22651](#) (196.85 mm)

SHEAVE

- [TCU26967](#) (OD = 187.10 mm)

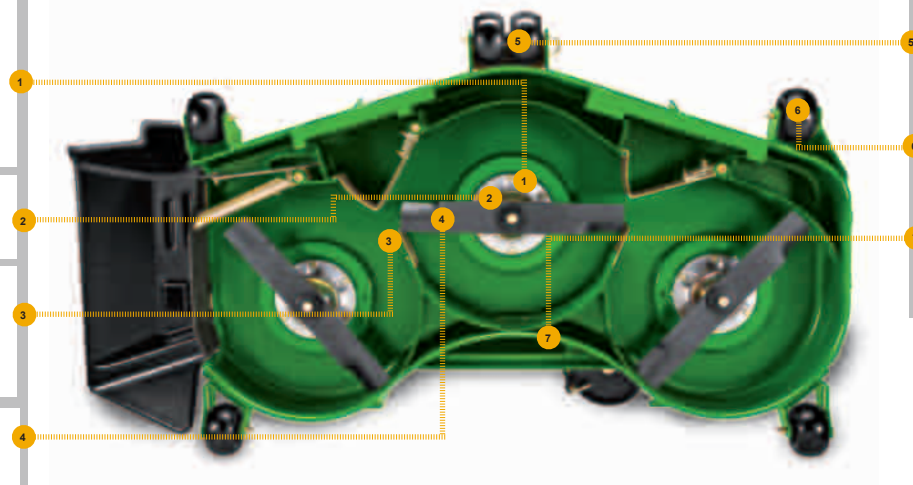

MOWER DECK

-  **ROLLER**
[TCU34060](#)

-  **GAGE WHEEL**
[UC28193](#)

-  **V - BELT**
[TCU35604](#) (LGTH = 4635 mm,
WIDTH = 14 mm, TK = 18 mm)

REPLACEMENT PARTS GUIDE

Z970R With 60 inch Deck

MOWER DECK

MOWER BLADE

- [TCU15882](#) (HIGH LIFT)
- [M141669](#) (LOW LIFT)
- [M142514](#) (MULCH)

SPINDLE KIT

- [AUC12478](#)

IDLER

- [AUC11584](#) (OD = 201 mm)
- [TCA20602](#) (OD = 148 mm)
- [TCA22651](#) (OD = 196.85 mm)

SHEAVE

- [TCU26968](#) (OD = 215.17 mm)

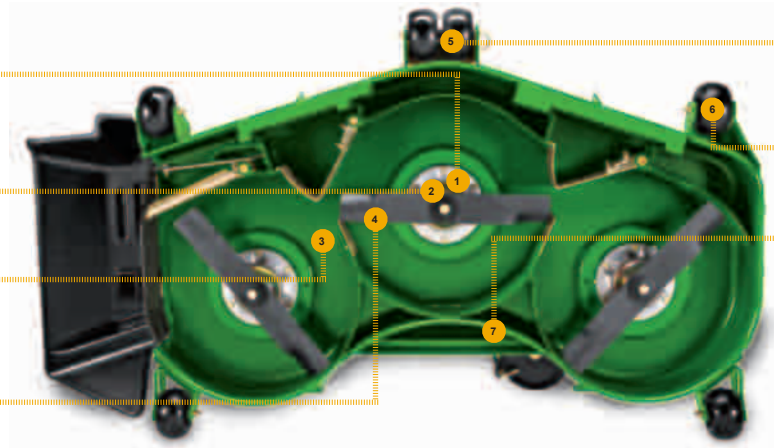

MOWER DECK

-  **ROLLER**
[TCU34060](#)





-  **GAGE WHEEL**
[UC28193](#)

-  **V - BELT**
[TCU35604](#) (LGTH = 4635 mm,
WIDTH = 14 mm, TK = 18 mm)

REPLACEMENT PARTS GUIDE



Z970R With 72 inch Rear Discharge Deck

MOWER DECK

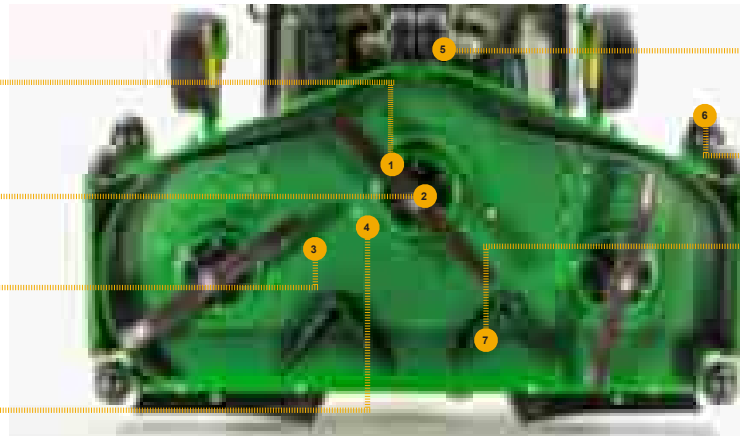
	MOWER BLADE EPC201693
	SPINDLE KIT AUC12478
	IDLER AUC11584 (OD = 201 mm) TCA20602 (OD = 148 mm) TCA22651 (OD = 196.85 mm)
	SHEAVE TCU26968 (OD = 215.17 mm)



MOWER DECK

	ROLLER TCU34060
	GAGE WHEEL UC28193
	V - BELT UC21914 (LGTH = 5010 mm, WIDTH = 14 mm, TK = 18 mm)