

# REPLACEMENT PARTS GUIDE

## Z435 EZtrak™ Residential Zero Turn Mower

### ENGINE



#### OIL FILTER

[AM125424](#)

Change every 50 Hrs / Annually.



#### ENGINE OIL

[TY22029](#) (Turf-Gard™ - 10W-30)  
(WITH FILTER) (1.75 L (1.85 qt))

Change every 50 Hrs / Annually .



#### AIR FILTER

[MIU13120](#)

Change every 100 Hrs / Annually.



#### JOHN DEERE MULTI-PURPOSE HD LITHIUM COMPLEX GREASE

[TY24416](#)

#### GREASE GUN

[TY26518](#)

Change As Required.



#### FUEL FILTER

[AM116304](#)

Change every 100 Hrs / Annually.



#### SPARK PLUG

[MIU11020](#)

#### HOME MAINTENANCE KIT

[LG269](#)



### ELECTRICAL



#### IGNITION SWITCH

[TCA22740](#)



#### IGNITION KEY

[AUC12681](#)



#### BATTERY

[TY25221B](#) (12 V) (FOR CANADA AND USA)

[MCYP340PF](#) (12 V) (NOT FOR CANADA AND USA)

### FUEL & AIR



#### FILLER CAP

[MIU804759](#)



#### MUFFLER

[GY22304](#)

### TRANSMISSION/ HYDRAULIC





#### TRACTION DRIVE BELT



[M169705](#) (LGTH = 2807.0 mm (110.5 inch))

# REPLACEMENT PARTS GUIDE

## Z435 with 48 inch Convertible Deck

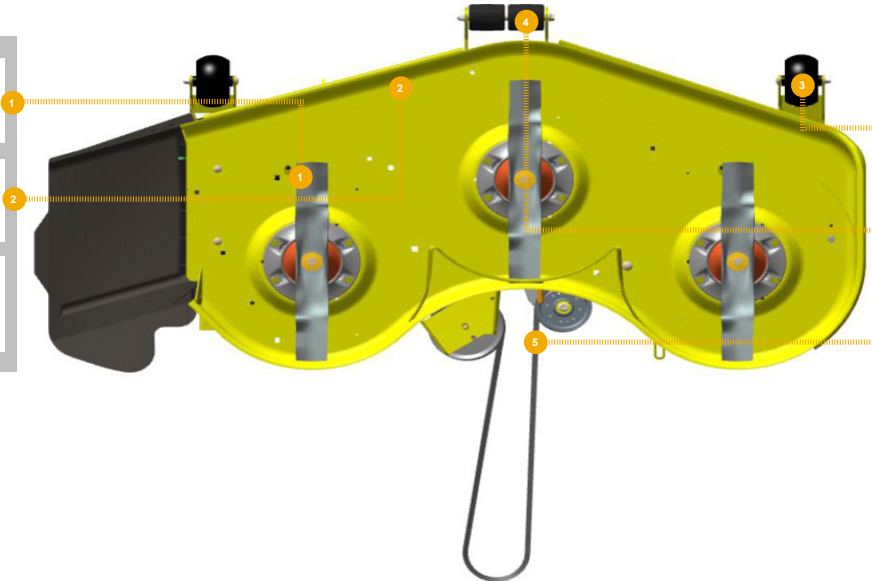

-  **MOWER BLADE**  
[UC22009](#)
-  **MULCH KIT**  
[M127673](#) (MULCH BLADE)
-  **MOWER DECK LEVELLING**  
[AM130907](#)







-  **GAGE WHEELS**  
[GX10168](#)
-  **ROLLER**  
[M113955](#)
-  **V BELT**  
[M158131](#) (LGTH = 3867.6 mm,  
WIDTH = 14.3 mm, TK = 11.1 mm)

# REPLACEMENT PARTS GUIDE

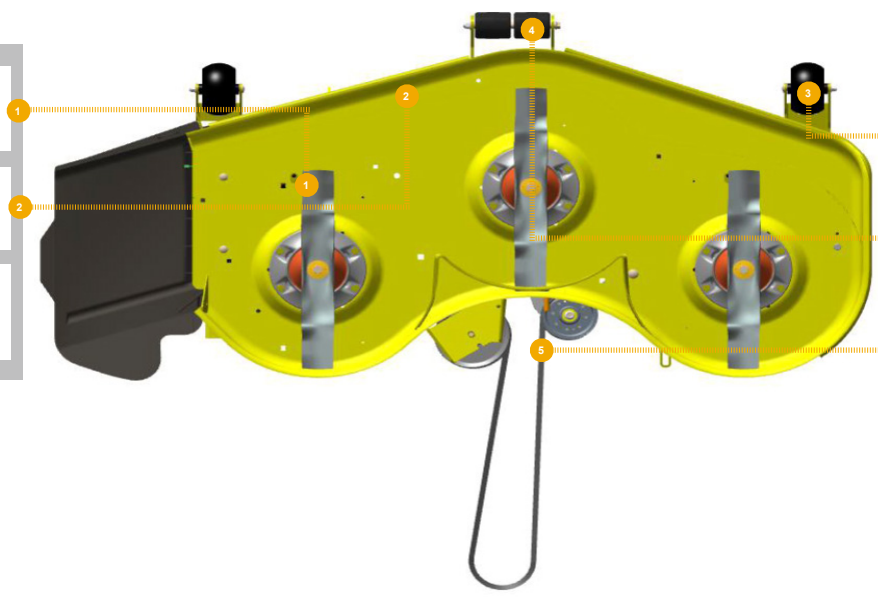
## Z435 with 54 inch Convertible Deck

-  **MOWER BLADE**  
[UC22010](#)
-  **MULCH KIT**  
[M145516](#) (MULCH BLADE)
-  **MOWER DECK LEVELLING**  
[AM130907](#)



-  **GAGE WHEELS**  
[GX10168](#)
-  **ROLLER**  
[M113955](#)
-  **V BELT**  
[M158131](#) (LGTH = 3867.6 mm,  
WIDTH = 14.3 mm, TK = 11.1 mm)