

MAINTENANCE REMINDER SHEET

X354 with 42" Accel Deep™ Deck

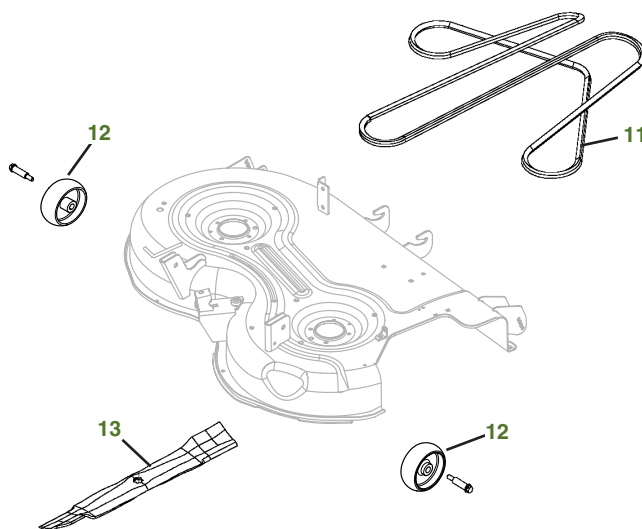
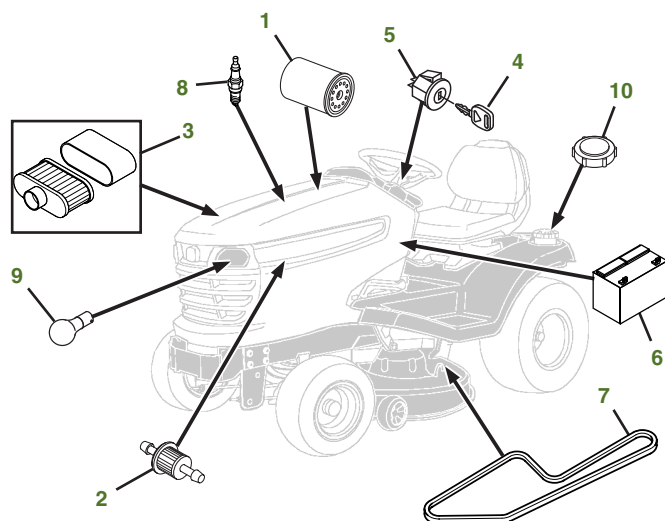

Tractor S/N

Deck S/N

Key	Part No.	Description	Key	Part No.	Description
1	AM125424	ENGINE OIL FILTER	7	M144044	BELT-TRACTION DRIVE
2	AM116304	FUEL FILTER-IN-LINE	8	M805853	SPARK PLUG
3	MIU12554	AIR FILTER-FOAM	9	AD2062R	HEADLIGHT BULB
	MIU12555	AIR FILTER-PAPER	10	AM141406	FUEL CAP
4	GY20680	KEY	11	M174994	BELT-MOWER
5	AM133597	IGNITION SWITCH	12	GX10168	GAGE WHEEL
6	TY25221	BATTERY	13	M170639	KIT-SIDE DISCHARGE 42"
				GX25668	KIT-BAGGING 42"
				M170642	KIT-MULCHING 42"
				BM24794	MulchControl™ KIT

Parts Needed in First 250 Hours of Operation

Qty	Part No	Item	Qty or Capacity	Change Interval In Hours
4	TY22029	Engine Oil Turf-Gard™ 10W30	1.7 L (1.8 qt)	100/200
2	AM125424	Engine Oil Filter	1	100/200
2	MIU12554	Air Filter-Foam	1	100/200
2	MIU12555	Air Filter-Paper	1	100/200
2	AM116304	Fuel Filter-In-Line	1	100/200
4	M805853	Spark Plug	2	100/200
2	TY24416	John Deere Multi-Purpose HD Lithium Complex Grease		As Needed

"As Needed" Parts

Qty	Part No	Item
1	AM130907	Mower Deck Leveling Gauge
1	TY26518	Grease Gun

Home Maintenance Kit

Unit	Kit Number
X354	LG265

CLICK PART NUMBER TO BUY